

Absolute, Non-Contact Position Sensors

M-Series PWM

Temposonics MH
Measuring Length 50 - 2500 mm



Compact Sensor for Mobile Hydraulics

- Linear, absolute Measurement in Hydraulic Cylinders
- Non-Contact Sensing with Highest Durability
- Compact Dimensions
- Accuracy: Linearity Tolerance $< \pm 0,04\%$
- Hysteresis $< \pm 0,1$ mm
- Direct PWM Output: Displacement
- Power Supply: 12/24 VDC
- Immunity against electromagnetic HF-fields up to 200 V/m
- Shockrating: 100 g (singlehit) / IEC 68-2-27



Designed for the Mobile World

M-Series sensors were designed with the "mobile" world in mind, and have been validated in the field by customers worldwide. Performance is second to none; high accuracy, 200 V/m EMI position output. Ruggedness is "designed in", 100 g shock rating. The MH sensor can be fully sealed and embedded in a cylinder to ensure a long operation life. The direct connection to the Temposonics® M12 connector system and other proven mobile connectors are possible.

Magnetostriction

The absolute **Temposonics**® linear position sensors are based on the MTS developed magnetostrictive measurement principle. That combines various magneto-mechanical effects and uses the physical height precise speed-measurement of an ultrasonic wave (torsion pulse in its sensor element) for position detecting. Sensor integrated signal processing transforms the measurements directly into market standard outputs. The non-contact principle - an external movable magnet marks the position - eliminates the wear, noise and erroneous signal problems and guarantees the best durability without any recalibration.

Measuring Principle

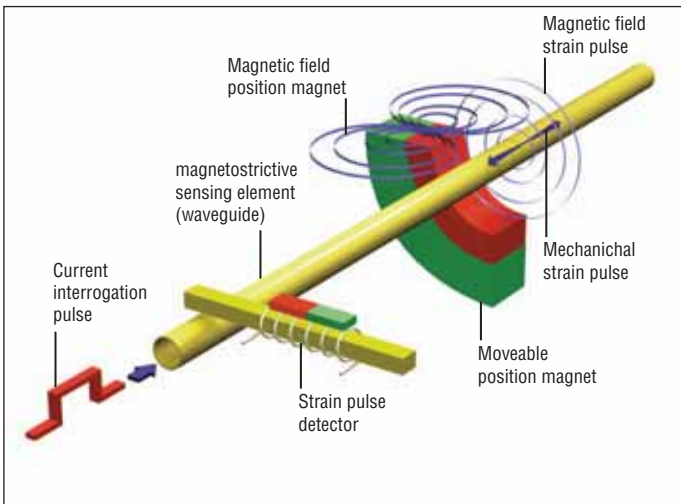

Measuring Principle (simplified illustration)

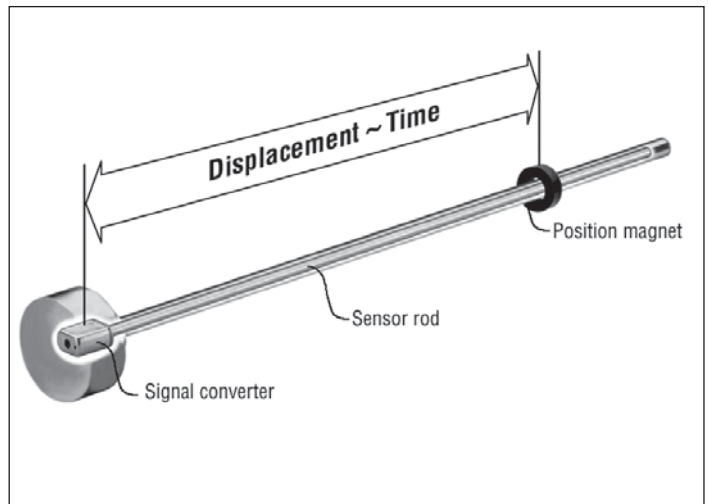

Temposonics MH - High Pressure Compact Sensor Measuring Range 50 2500 mm

Temposonics MH, the new compact stainless steel position sensor is designed for installation into hydraulic cylinders, specifically for use in clevis head mobile cylinders or any space limited cylinder applications. MH type sensors are ideal choices for a wide range of standard hydraulic cylinders. Magnetostrictive displacement sensors, high quality cylinders and precise control valves form ideal driving systems for technically demanding of mobile hydraulics.

Simple Mechanics

The extremely rugged sensor consist of the following main parts:

- The flange housing with singal converter and built-in electronics
- The pressure-proof sensor pipe (up to 450 bar) with flange protects the internal sensing element, the waveguide system. It fits into the bored piston rod
- The position magnet, only moving part is mounted into the piston bottom. This permanent magnet travels wearfree and contactless along the stationary sensor tube. Its magnetic field starts the measurement signal through the sensors rod wall
- The innovative Connector System can easily be mounted in a few seconds, any soldering or crimping needless, dust-and waterproof up to IP69K

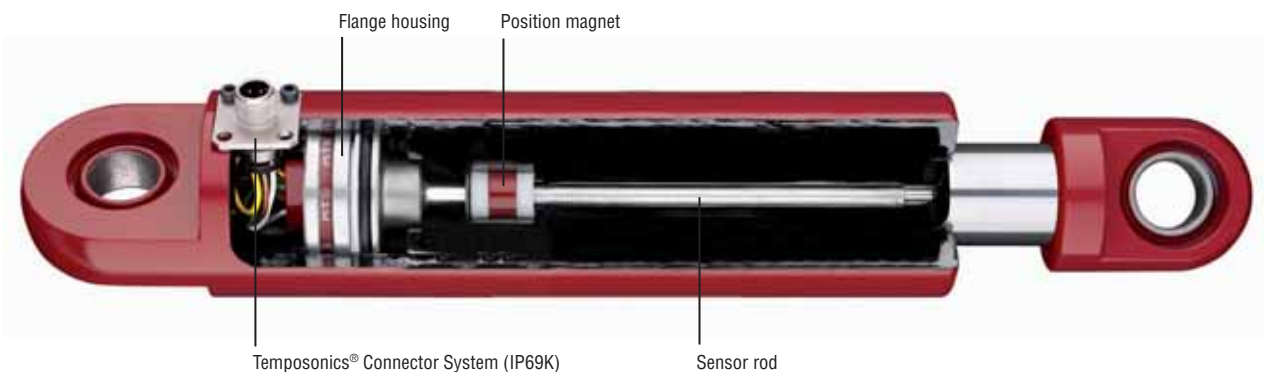

Technical Data

Input

Measured variables: Displacement
Measuring range: 50 - 2500 mm in 5 mm steps

Output

Interface: PWM
Resolution: The resolution is constant
PWM $\leq \pm 0,1$ mm
Signal output frequency: PWM adjustable 1 ms...65 ms

Accuracy

Linearity: 50...250 mm $\leq \pm 0,1$ mm
255...2000 mm $\leq \pm 0,04$ % full stroke
500 mm $\leq \pm 0,2$ mm
750 mm $\leq \pm 0,3$ mm
1250 mm $\leq \pm 0,5$ mm
2005...2500 mm $\leq \pm 0,8$ mm
Hysteresis: $\pm 0,1$ mm
Cycle Time: 1 ms
Setpoint Tolerance: $\pm 0,2$ mm

Operating conditions

Assembly orientation: In any direction
Operating temperature electronics, storage temp.: -40°C...+105°C
Fluid temperature: -30°C...+105°C
Dew point, humidity: 90 % rel. humidity, no condensation acc. EN60068-2-30

Pressure

Operating pressure ratings:	Ø 10 mm sensor rod	Ø 7 mm sensor rod	
	PN: 350 bar	PN: 300 bar	Pressure pulse test acc.
	Pmax: 450 bar	Pmax: 400 bar	DIN EN ISO 19879

IP rating

M12 connector: IP69K plugged, EN60529
Sensor housing: IP67, EN60529

Environmental testing:

Shock: IEC-68-2-27
100 g (11 ms) single hit
50 g (11 ms) at 1000 Shocks per axis
Vibration: IEC 68-2-6 (10...2000 Hz)
Ø 10 mm sensor rod 25 g
Ø 7 mm sensor rod 15 g
EMC: ISO 14982 agricultural and forestry machines
ISO 11452-2 (transient emissions, antenna)
ISO 11452-4 (transient emissions, bulk current injection)
ISO 11452-5 (transient emissions stripline - 200 V/m)
DIN EN 50121-3-2 EMC for rail vehicles
ISO 7637-1/2 road vehicles
CE certified acc. to EG directives 89/336/EWG (12/24 VDC)

Materials and dimensions

Sensor rod: Stainless steel 1.4306 / AISI 304L (Ø 10 mm / Ø 7 mm)
Housing: Stainless steel 1.4305 / AISI 303
Mechanical assembly: Flange housing Ø 48 mm
O-ring 40.87 x 3.53 mm NBR 80, backup ring 42.6 x 48 x 1.4 PTFE

Electrical installation

Outputs: Connector System M12x1 with O-ring 7 x 1,35 mm NBR 70
Connecting flange brass nickel-plated with O-ring 13 x 1,6 NBR 70
Supply voltage: 12/24 VDC (tolerance range 8 - 32 VDC)
Voltage supply ripple: < 1 % p-p
Power drain: < 1,5 W
Electric strength: 500 VDC (DC ground to machine ground)
Polarity protection (GND - VDC - Signal): Up to -36 VDC
Over voltage protection (GND - VDC): Up to 36 VDC

Temposonics® Connector System M12

MTS presents the innovative Connector System for Temposonics® M-Series

The Temposonics® Connector System meets the most exacting protection requirements important for the difficult environmental conditions of mobile hydraulics applications. Protection type IP69K makes the robust metal housing not only completely dust- and waterproof, even the harshest cleaning measures can not damage the sensor.

A The MH sensor is delivered by MTS together with the new Connector System: The connector insert carrier is already connected to the sensor conductors, i.e. no soldering, any colour or connection mistake.

B The connector insert is taken out of the cylinder through a bore hole. The flange housing can be clicked in position easily from outside.

C Four standard screws must be tightened to mount the Connector System on the cylinder.

D With a corresponding mating plug the Connector System fulfills an IP rating of IP69K.

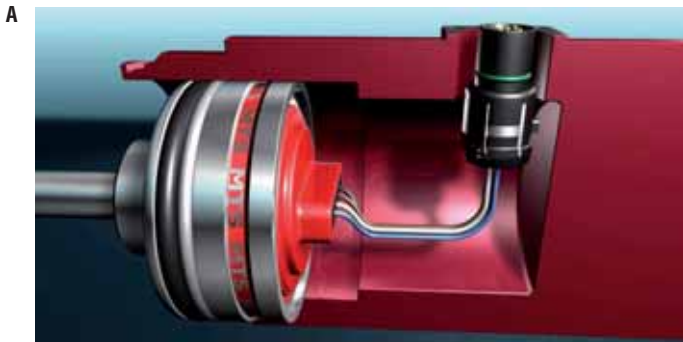

Electrical Connection / Dimensions

M12 connector system
4 single wire, 0,5 mm²

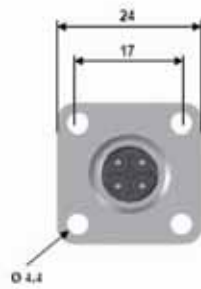
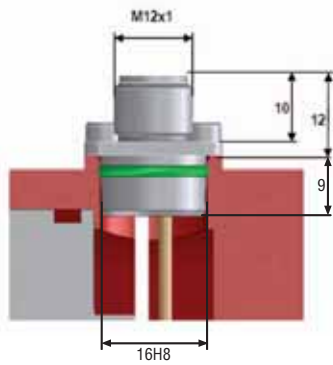
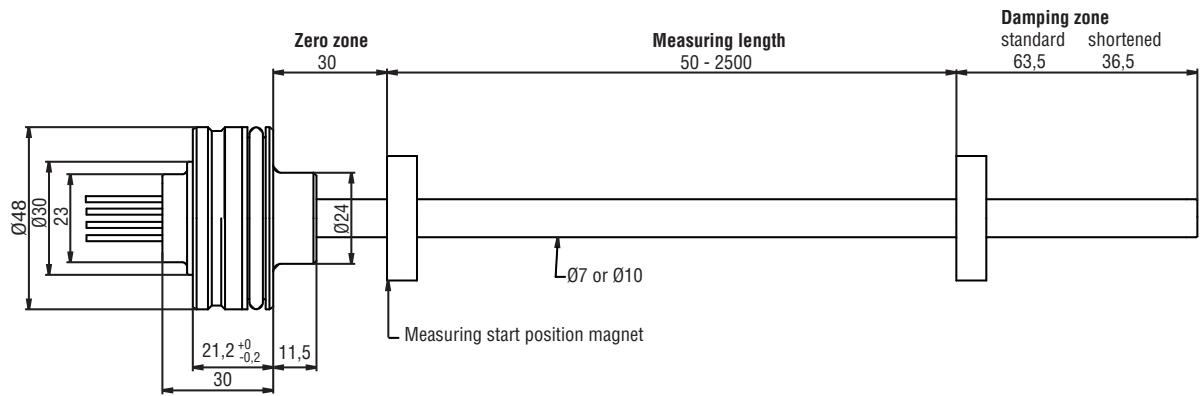

Pin Assignment

Pin	Signal
1	N.C.
2	Power Supply 12/24 VDC
3	DC Ground
4	PWM

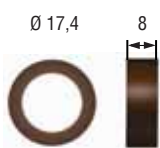

Ring magnet Part No. 401032
OD 17,4 mm
ID 13,5 mm
Height 8 mm
Surface pressure max. 10 N/mm²*
in axial direction

*max. mechanical burden, e.g. by circlip, lock washers etc.

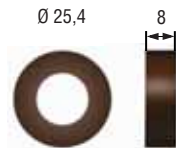

Ring magnet Part No. 400533
OD 25,4 mm
ID 13,5 mm
Height 8 mm
Surface pressure max. 40 N/mm²*
in axial direction

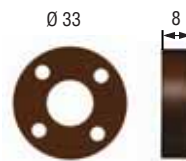

Ring magnet Part No. 201542-2
OD 33 mm
ID 13,5 mm
Height 8 mm
Fixing holes 4,2 mm, circle Ø24 mm
Surface pressure max. 40 N/mm²*
in axial direction
Fastening torque for screws M4:
max 1 Nm

Mechanical Installation

The robust Temposonics® model MH sensor's new stainless-steel housing is designed for direct stroke measurement in hydraulic cylinders. The Temposonics® MH sensor can be installed from the head side or the rod side of the cylinder depending on the cylinder design.

Example

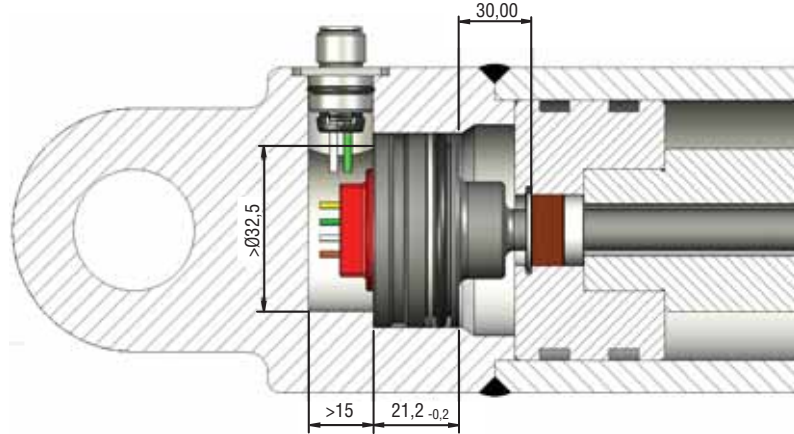

Sensor Installation

The method of installation is entirely dependent on the cylinder design. While the most common method of installation is from the rod side of the cylinder, installation from the head side of the cylinder is also possible. In both installation methods, the cylinder is sealed by O-ring and backup ring which is ready installed on the sensor housing.

Installation Notes

- Use a non-ferrous circlip to fix the magnet.
- The bore in the piston rod is dependent on hydraulic pressure and piston velocity etc. The minimum drilling should be 10 (7 mm rod) or 13,5 mm (10 mm rod).

1. Installation in magnetic Material with Spacer

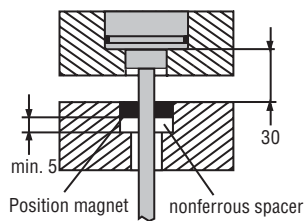

2. Installation in non-magnetic Material without Spacer

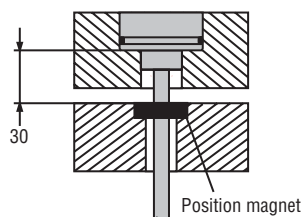

All dimensions in mm.

Detail Flange Housing

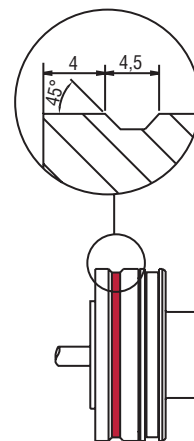

e.g. retaining with set screw DIN 913
M5x10 (with flat point!)
max. torque 0,5 Nm

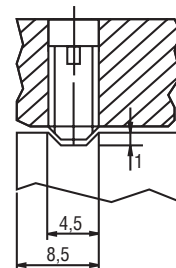

Temposonics

M H

M

3

Sensor model

MH = Hydraulic rod /
Flange housing Ø 48 mm

Form factor

C = Rod-Ø 10 mm (damping zone 63,5 mm)
D = Rod-Ø 7 mm (damping zone 63,5 mm)
E = Rod-Ø 10 mm (reduced damping zone 36,5 mm)
F = Rod-Ø 7 mm (reduced damping zone 36,5 mm)
R = Rod-Ø 10 mm with rod end plug,
threaded hole M4 (damping zone 63,5 mm)

Measuring length

0050 - 2500 mm in 5 mm steps

Connection type

Single wires with Connector System M12

N__E = 4 single wires, 0,5 mm² with Connector System M12 IP69K, 4 pin
N06E = 60 mm min. wire length
N25E = 250 mm max. wire length

Input

3 = +12/24 VDC

Output

P__ = PWM

15. digit: Span range **A** = 5 - 95 % • **B** = 10 - 90 % • **C** = 15 - 85 % • **D** = 20 - 80 % • **E** = 25 - 75 %

16. digit: Frequency **A** = 50 Hz • **B** = 60 Hz • **C** = 100 Hz • **D** = 200 Hz • **E** = 300 Hz • **F** = 400 Hz
G = 500 Hz • **X** = not defined

Scope of delivery

Position sensor, O-Ring, backup-ring
M12 connector system

Please order magnets seperately!

Accessories (selection)	Part No.
OD17,4 Ring magnet	401 032
OD25,4 Ring magnet	400 533
OD33 Ring magnet	201 542-2

www.mtssensor.com
www.temposonics-shop.de

© MTS Temposonics® M-Series MH PWM 551226a-(GB) - Alterations reserved



Germany

MTS Sensor Technologie
GmbH & Co. KG
Auf dem Schüffel 9
58513 Lüdenscheid, Germany
Tel.: +49-2351-9587-0
Fax: +49-2351-56491
info@mtssensor.de
www.mtssensor.com

USA

MTS Systems Corporation
Sensors Division
3001 Sheldon Drive
Cary, NC 27513, USA
Tel.: +1-919-677-0100
Fax: +1-919-677-0200
sensorsinfo@mts.com
www.mtssensors.com

Japan

MTS Sensors Technology Corp.
737 Aihara-cho,
Machida-shi
Tokyo 194-0211, Japan
Tel.: +81-42-775-3838
Fax: +81-42-775-5516
info@mtssensor.co.jp
www.mtssensor.co.jp